

KENWOOD

DOUBLE DIN SIZED CD/CASSETTE RECEIVER

DPX-MP4070

INSTRUCTION MANUAL

KENWOOD CORPORATION



Contents

Warning **3**

Safety precautions **4**

WARNING
CAUTION
NOTE

Notes **6**

About Cassette tape **6**

About CDs **7**

Notes on playing MP3/WMA **8**

General features **10**

Power
Selecting the Source
Volume
Attenuator
Audio Control
Subwoofer Output
TEL Mute
SRS WOW Select
SRS WOW Control
Equalizer Control
Adjustment of Equalizer type at EASY
Adjustment of Equalizer type at PRO
Memory preset of adjustment of Equalizer type
Movie Select
Switching Display
Illumination Color Select
User Illumination Color Setting
Adjusting Clock
Station/Disc Naming (SNPS/DNPS)
Auxiliary Input Display Setting

Tuner features **17**

Tuning
Direct Access Tuning
Station Preset Memory
Auto Memory Entry
Preset Tuning

Cassette player features **19**

Playing Cassette Tapes
Fast Forwarding and Rewinding
Dolby B NR
Selecting the Tape type
DPSS (Direct Program Search System)
DPSS with the Remote
Blank Skip

Index Scan
Music Repeat

CD/ MP3/ WMA/ External disc control features **21**

Playing CD & MP3/WMA
Playing External Disc
Fast Forwarding and Reversing
Track/File Search
Disc Search/Folder Search
Direct Track/File Search
Direct Disc Search
Track/File/Disc/Folder Repeat
Scan Play
Random Play
Magazine Random Play
Folder Select
Text/Title Scroll

Function Set **24**

Function Set
Illumination Color Mode
Contrast Adjustment
Touch Sensor Tone
Switching preout
Opening Demonstration
Equalizer mode
Security Code
Navigation Mute
TEL Mute
Built-in Auxiliary input Setting
Built-in Amp Mute Setting
Security Indicator
CD Read Setting
Tuning Mode
Monaural Reception
Auto Memory Entry
Text Scroll

Basic Operations of remote **28**

Accessories **30**

Installation Procedure **31**

Connecting Wires to Terminals **32**

Installation **33**

Troubleshooting Guide **36**

Specifications **40**

▲Warning

▲CAUTION

Use of controls or adjustments or performance of procedures other than those specified herein may result in hazardous radiation exposure. In compliance with Federal Regulations, following are reproductions of labels on, or inside the product relating to laser product safety.

KENWOOD CORPORATION
2967-3, ISHIKAWA-CHO,
HACHIOJI-SHI
TOKYO, JAPAN

KENWOOD CORP. CERTIFIES THIS EQUIPMENT
CONFORMS TO DHHS REGULATIONS N0.21 CFR
1040. 10, CHAPTER 1, SUBCHAPTER J.

Location : Bottom Panel

FCC WARNING

This equipment may generate or use radio frequency energy. Changes or modifications to this equipment may cause harmful interference unless the modifications are expressly approved in the instruction manual. The user could lose the authority to operate this equipment if an unauthorized change or modification is made.

NOTE

This equipment has been tested and found to comply with the limits for a Class B digital device, pursuant to Part 15 of the FCC Rules. These limits are designed to provide reasonable protection against harmful interference in a residential installation. This equipment may cause harmful interference to radio communications, if it is not installed and used in accordance with the instructions. However, there is no guarantee that interference will not occur in a particular installation. If this equipment does cause harmful interference to radio or television reception, which can be determined by turning the equipment off and on, the user is encouraged to try to correct the interference by one or more of the following measures:

- Reorient or relocate the receiving antenna.
- Increase the separation between the equipment and receiver.
- Connect the equipment into an outlet on a circuit different from that to which the receiver is connected.
- Consult the dealer or an experienced radio/TV technician for help.

Safety precautions

▲WARNING

To prevent injury or fire, take the following precautions:

- Insert the unit all the way in until it is fully locked in place. Otherwise it may fall out of place when jolted.
- When extending the ignition, battery, or ground wires, make sure to use automotive-grade wires or other wires with a 0.75mm^2 (AWG18) or more to prevent wire deterioration and damage to the wire coating.
- To prevent a short circuit, never put or leave any metallic objects (such as coins or metal tools) inside the unit.
- If the unit starts to emit smoke or strange smells, turn off the power immediately and consult your Kenwood dealer.
- Make sure not to get your fingers caught between the faceplate and the unit.
- Be careful not to drop the unit or subject it to strong shock.
The unit may break or crack because it contains glass parts.
- Do not touch the liquid crystal fluid if the LCD is damaged or broken due to shock. The liquid crystal fluid may be dangerous to your health or even fatal.
If the liquid crystal fluid from the LCD contacts your body or clothing, wash it off with soap immediately.

▲CAUTION

To prevent damage to the machine, take the following precautions:

- Make sure to ground the unit to a negative 12V DC power supply.
- Do not open the top or bottom covers of the unit.
- Do not install the unit in a spot exposed to direct sunlight or excessive heat or humidity. Also avoid places with too much dust or the possibility of water splashing.
- When replacing a fuse, only use a new one with the prescribed rating. Using a fuse with the wrong rating may cause your unit to malfunction.
- To prevent a short circuit when replacing a fuse, first disconnect the wiring harness.
- Do not use your own screws. Use only the screws provided. If you use the wrong screws, you could damage the unit.

About CD players/disc changers connected to this unit

KENWOOD disc changers/ CD players released in 1998 or later can be connected to this unit.

Refer to the catalog or consult your Kenwood dealer for connectable models of disc changers/ CD players.

Note that any KENWOOD disc changers/ CD players released in 1997 or earlier and disc changers made by other makers cannot be connected to this unit. Unsupported connection may result in damage. Setting the "O-N" Switch to the "N" position for the applicable KENWOOD disc changers/ CD players. The functions that can be used and the information that can be displayed will differ depending on the models being connected.



- You can damage both your unit and the CD changer if you connect them incorrectly.

NOTE

- If you experience problems during installation, consult your Kenwood dealer.
- If the unit fails to operate properly, press the Reset button. The unit returns to factory settings when the Reset button is pressed. If the unit still fails to operate properly after the Reset button has been pressed, contact your local KENWOOD dealer for assistance.
- Press the reset button if the Disc auto changer fails to operate correctly. Normal operation should be restored.

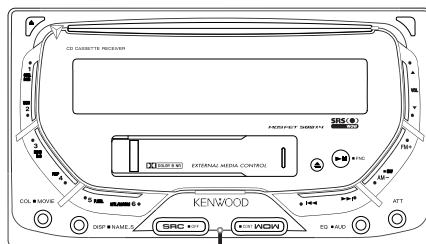

Reset button

- Characters in the LCD may become difficult to read in temperatures below 41 °F (5 °C).
- The illustrations of the display and the panel appearing in this manual are examples used to explain more clearly how the controls are used. Therefore, what appears on the display in the illustrations may differ from what appears on the display on the actual equipment, and some of the illustrations on the display may represent something impossible in actual operation.

Lens Fogging

Right after you turn on the car heater in cold weather, dew or condensation may form on the lens in the Disc player of the unit. Called lens fogging, Discs may be impossible to play. In such a situation, remove the disc and wait for the condensation to evaporate. If the unit still does not operate normally after a while, consult your Kenwood dealer.

Notes

Cleaning the Unit

If the faceplate of this unit is stained, wipe it with a dry soft cloth such as a silicon cloth.

If the faceplate is stained badly, wipe the stain off with a cloth moistened with neutral cleaner, then wipe neutral detergent off.



- Applying spray cleaner directly to the unit may affect its mechanical parts. Wiping the faceplate with a hard cloth or using a volatile liquid such as thinner or alcohol may scratch the surface or erase characters.

Cleaning the CD Slot

As dust tends to accumulate in the CD slot, clean it every once in a while. Your CDs can get scratched if you put them in a dusty CD slot.

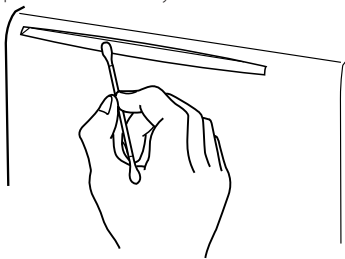

NOTE

This Class B digital apparatus complies with Canadian ICES-003.

WOW, SRS and (●) symbol are trademarks of SRS Labs, Inc.

WOW technology is incorporated under license from SRS Labs, Inc.

Manufactured under license from Dolby Laboratories.

"Dolby" and the double-D symbol are trademarks of Dolby Laboratories.

About Cassette tape

Cleaning the tape head

When there's noise or the sound quality is bad during tape play the tape head maybe dirty, clean the tape head.

About Cassette tape

- If the tape is slack tighten it.
- If the cassette tape label is peeling off glue it on again.
- Don't use deformed cassette tape.
- Don't place cassette tape on the dashboard etc. where the temperature is high.
- Don't use cassette tape that's 100 minutes long or longer.

About CDs

Handling CDs

- Don't touch the recording surface of the CD.



- CD-R and CD-RW are easier to damage than a normal music CD. Use a CD-R or a CD-RW after reading the caution items on the package etc.
- Don't stick tape etc. on the CD. Also, don't use a CD with tape stuck on it.

When using a new CD

If the CD center hole or outside rim has burrs, use it after removing them with a ball pen etc.

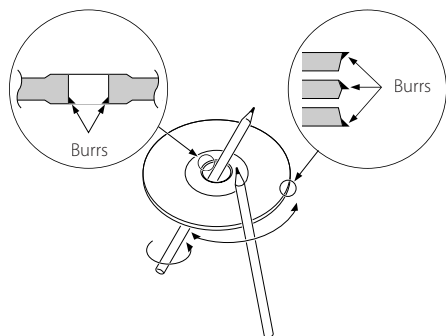

CD accessories

Don't use disc type accessories.

CD cleaning

Clean from the center of the disc and move outward.

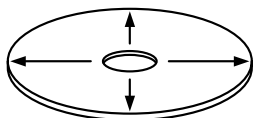

Removing CDs

When removing CDs from this unit pull them out horizontally.

CDs that can't be used

- CDs that aren't round can't be used.

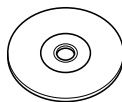

- CDs with coloring on the recording surface or that are dirty can't be used.
- This unit can only play the CDs with



It may not correctly play discs which do not have the mark.

- A CD-R or CD-RW that hasn't been finalized can't be played. (For the finalization process refer to your CD-R/CD-RW writing software, and your CD-R/CD-RW recorder instruction manual.)

CD storage

- Don't place them in direct sunlight (On the seat or dashboard etc.) and where the temperature is high.
- Store CDs in their cases.

Notes on playing MP3/WMA

Note, however, that the MP3/WMA recording media and formats acceptable are limited. When writing MP3/WMA, pay attention to the following restrictions.

Acceptable media

The MP3/WMA recording media acceptable to this unit are CD-ROM, CD-R, and CD-RW. When using CD-RW, do full format not quick format to prevent malfunction.

Acceptable medium formats

The following formats are available for the media used in this unit. The maximum number of characters used for file and folder name including the delimiter (".") and three-character extension are indicated in parentheses.

- ISO 9660 Level 1 (12 characters)
- ISO 9660 Level 2 (31 characters)
- Joliet (64 character; Up to 32 characters are displayed)
- Romeo (128 character; Up to 64 characters are displayed)
- Long file name (200 characters; Up to 64 characters are displayed)
- Maximum number of characters for folder name: 64 (Joliet; Up to 32 characters are displayed)

For a list of available characters, see the instruction manual of the writing software and the section Entering file and folder names below.

The media reproducible on this unit has the following limitations:

- Maximum number of directory levels: 8
- Maximum number of files per folder: 255
- Maximum number of folders: 50
- Maximum number of files and folders: 512

MP3/WMA written in the formats other than the above may not be successfully played and their file names or folder names are not properly displayed.

Settings for your MP3/WMA encoder and CD writer

Do the following setting when compressing audio data in MP3/WMA data with the MP3/WMA encoder.

- Transfer bit rate: MP3: 8 —320 kbps
WMA: 48 —192 kbps
- Sampling frequency
MP3: 8, 11.025, 12, 16, 22.05, 24, 32, 44.1, 48 kHz
WMA: 32, 44.1, 48 kHz

When you use your CD writer to record MP3/WMA up to the maximum disc capacity, disable additional writing. For recording on an empty disc up to the maximum capacity at once, check Disc at Once.



- Play mode may not be possible when portions of the functions of Windows Media Player 9 or higher are used.

Entering ID3 tag

The Displayable ID3 tag is ID3 version 1.x.

For the character code, refer to the List of Codes.

0	1	2	3	4	5	6	7	8	9	A	B	C	D	E	F
0			0	@	P		p			°	À	Ä	à	ä	
1			1	!	A	O	a	q		ı	#	Å	Ñ	ã	ñ
2			"	2	B	R	b	r		ç	²	Á	Ö	á	ö
3			#	3	C	S	c	s		£	³	Â	Ó	â	ó
4			\$	4	D	T	d	t		¤	´	Ä	Ö	ä	ö
5			%	5	E	U	e	u		¥	µ	Å	Ö	å	ö
6			&	6	F	V	f	v		:	¶	Æ	Ö	æ	ö
7			'	7	G	W	g	w		\$	·	Ç	×	ç	×
8			(8	H	X	h	x		¿	†	É	Ö	é	ö
9)	9	I	Y	i	y		©	1	Ê	Ü	ê	ü
A			.		J	Z	j	z		ª	²	Ë	Ü	ë	ü
B			+		K	[k	[«	»	È	Ü	è	ü
C			<		L	\	l	\		¼	½	Í	Ü	í	ü
D			-		M		m			¾		I	Y	i	y
E			>		N	^	n	^		®	®	Ë	Ü	ë	ü
F			/	?	_	o	_	o		■			I		i

Entering file and folder names

The code list characters are the only file names and folder names that can be entered and displayed.

If you use any other character for entry, the file and folder names are not displayed correctly. They may neither be displayed correctly depending on the CD writer used.

The unit recognizes and plays only those MP3/WMA which have the MP3/WMA extension (.MP3/WMA).



- A file with a name entered with characters not on the code list may not play correctly.

Writing files into a medium

When a medium containing MP3/WMA data is loaded, the unit checks all the data on the medium. If the medium contains a lot of folders or non-MP3/WMA files, therefore, it takes a long time until the unit starts playing MP3/WMA.

In addition, it may take time for the unit to move to the next MP3/WMA file or a File Search or Folder Search may not be performed smoothly.



Loading such a medium may produce loud noise to damage the speakers.

- Do not attempt to play a medium containing a non-MP3 file with the MP3 extension.
The unit mistakes non-MP3 files for MP3/WMA data as long as they have the MP3 extension.
- Do not attempt to play a medium containing non MP3.

MP3/WMA playing order

When selected for play, Folder Search, File Search, or for Folder Select, files and folders are accessed in the order in which they were written by the CD writer.

Because of this, the order in which they are expected to be played may not match the order in which they are actually played. You may be able to set the order in which MP3/WMA are to be played by writing them onto a medium such as a CD-R with their file names beginning with play sequence numbers such as "01" to "99", depending on your CD writer.

For example, a medium with the following folder/file hierarchy is subject to Folder Search, File Search, or Folder Select as shown below.

Example of a medium's folder/file hierarchy

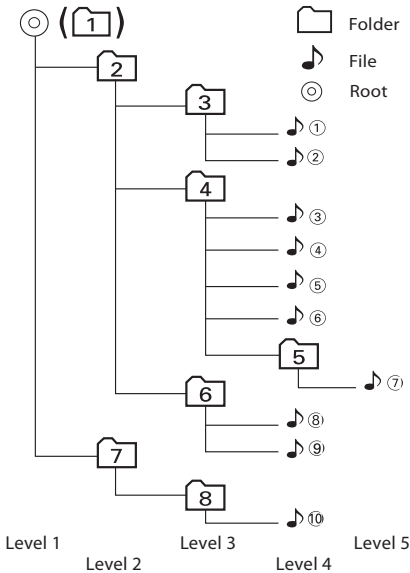

When a File Search is executed with file 4 being played ...

Operation of the button	(Current file: 4)
⏮ Button	Beginning of file 4 → 3
⏭ Button	5 → 6

When a Folder Search is executed with file 4 being played ...

Operation of the button	(Current folder: 4)
AM Button	3 → 2 → 1 → 8 ...
FM Button	5 → 6 → 7 → 8 → 1 ...

When Folder Select is selected with file 4 being played to move from folder to folder ...

Operation of the button	(Current folder: 4)
⏮ Button	3
⏭ Button	6
AM Button	2
FM Button	5

General features

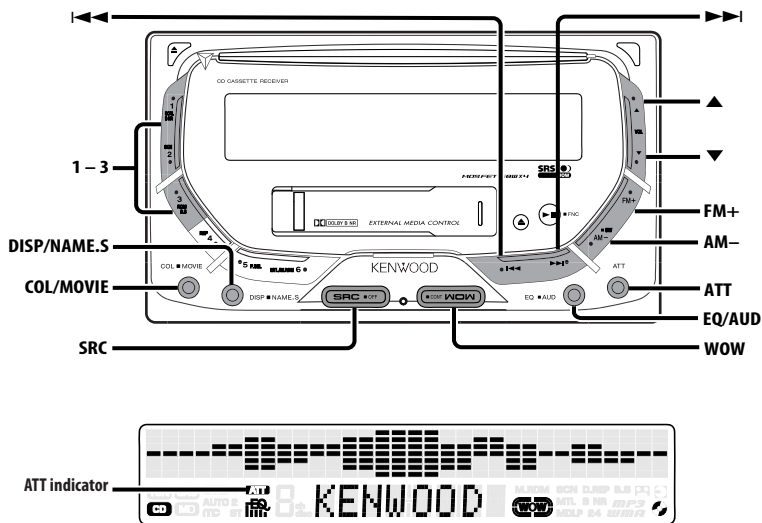

Power

Turning ON the Power

Press the [SRC] button.

Turning OFF the Power

Press the [SRC] button for at least 1 second.

Selecting the Source

Press the [SRC] button.

Source required	Display
Tuner	"TUNER"
Tape	"TAPE"
CD	"CD"
External disc (Optional accessory)	"CD CH"
Auxiliary input	"AUX"
Standby (Illumination only mode)	"STANDBY"

Volume

Increasing Volume

Press the [▲] button.

Decreasing Volume

Press the [▼] button.

Attenuator

Turning the volume down quickly.

Press the [ATT] button.

Each time the button is pressed the Attenuator turns ON or OFF.

When it's ON, the "ATT" indicator blinks.

Audio Control

1 Enter the Audio Control mode

Press the [AUD] button for at least 1 second.

"AUD mode" is displayed.

2 Select the Audio item for adjustment

Press the [FM+] or [AM-] button.

Each time the button is pressed, the items that can be adjusted switch as shown below.

3 Adjust the Audio item

Press the [◀◀] or [▶▶] button.

Adjustment Item	Display	Range
Balance	"BAL"	Left 15 — Right 15
Fader	"FAD"	Rear 15 — Front 15
Sub woofer level*1	"SubW"	-15 — +15
Bass boost level*2	"AmpB"	Flat/+6/ +12/ +18 (dB)
Central frequency boost*2	"AmpF"	Normal/ Low
Low Pass Filter*1	"LPF"	Through/120/80/50 Hz
Volume offset	"V-OFF"	-8 — ±0



- *1 You can control this item when 'Subwoofer Output' (page 11) is set to "SubW On".
- Volume offset: Each source's volume can be set as a difference from the basic volume.
- *2 - Refer to the catalog or instruction manual for power amplifiers that can be controlled from this unit.
 - For amplifiers there are the model that can be set from Flat to +18 dB, and the model that can be set from Flat to +12 dB.
 - When an amplifier that can only be set to +12 is connected to the unit, "AmpB +18" won't work correctly even if it's selected.

4 Exit the Audio Control mode

Press the [AUD] button.

Subwoofer Output

Turning the Subwoofer output ON or OFF.

Press the [AM-] button for at least 1 second.

Each time the button is pressed Subwoofer output switches ON or OFF.

When it's ON, "SubW On" is displayed.



- You can control this function when 'Switching preout' (page 25) is set to "SWPRE SW".

TEL Mute

The audio system automatically mutes when a call comes in.

When a call comes in

"CALL" is displayed.

The audio system pauses.

Listening to the audio during a call

Press the [SRC] button.

The "CALL" display disappears and the audio system comes back ON.

When the call ends

Hang up the phone.

The "CALL" display disappears and the audio system comes back ON.

SRS WOW Select

You can play back adding gorgeous heavy bass to the sound and making a 3D sound field.

1 Enter the WOW Select mode

Press the [WOW] button.

"WOW SEL" is displayed.

2 Select the WOW item

Press the [WOW] button.

Each time the button is pressed, the SRS WOW Select switch as shown below:

SRS WOW	Display
Moves the sound image up a notch and adjusts bass and the sound field.	"Low"
Moves the sound image up two notches and adjusts bass and the sound field.	"High"
Changes to the value set in 'SRS WOW Control'.	"User"
Returns to the normal sound without SRS WOW.	"Off"



- When operation stops for 3 seconds, the SRS WOW Select closes.
- WOW: TruBass, FOCUS and SRS 3D are all set to values shown below.

SRS WOW	SRS FOCUS	SRS TruBass	SRS 3D
High	High	On	On
Low	Low	On	On
Off	Off	Off	Off

General features

SRS WOW Control

Adjusts each function of SRS WOW individually.

1 Enter the WOW Control mode

Press the [WOW] button for at least 1 second.

"WOW CTRL" is displayed.

2 Select the WOW item for adjustment

Press the [FM+] or [AM-] button.

Each time the button is pressed, the items that can be adjusted switch as shown below.

3 Adjust the WOW item

Press the [◀◀] or [▶▶] button.

Adjustment Item	Display	Range
SRS FOCUS setting	"FOCUS"	0(Off)/1(Low)/2(High)
SRS TruBass setting	"TB"	Off/On
SRS 3D setting	"SRS"	Off/On

4 Exit the WOW Control mode

Press the [WOW] button.



- TruBass: Assisting the playback for the super bass sound.
- FOCUS: Adjusts the sound image by changing the vertical position of the speakers virtually and increases or decreases the soundscape.
- SRS 3D: Making a natural 3D sound field.
- SRS 3D cannot be set in tuner source.

Equalizer Control

You can recall the best sound setting preset for different types of the music.

1 Enter the Equalizer Control mode

Press the [EQ] button.

"EQ EASY" or "EQ PRO" is displayed.

2 Select the Equalizer type

Press the [EQ] button.

Each time the button is pressed, the Equalizer type switches as shown below:

Equalizer type	Display
Rock	"Rock"
Dance	"Dance"
Jazz	"Jazz"
Pops	"Pops"

Heavy	"Heavy"
Soft	"Soft"
Sharp	"Sharp"
Light	"Light"
Natural	"Natural"



- "User" display: The values set on the 'Adjustment of Equalizer type at PRO' (page 13).
- A selected Equalizer type can be adjusted. Adjustment items depend on the setting of 'Equalizer mode' (page 25). Refer to 'Adjustment of Equalizer type at EASY' (page 12) or 'Adjustment of Equalizer type at PRO' (page 13) for details of adjustment.

3 Exit the Equalizer Control mode

Press the [EQ] button for at least 1 second.

When operation stops for 10 seconds, the Equalizer type at that time is registered and the Equalizer Control mode automatically closes.

Adjustment of Equalizer type at EASY

Adjusting the effect of an Equalizer type selected in 'Equalizer Control' when 'Equalizer mode' is "EASY".

1 Refer to 'Equalizer Control' (page 12) to select the Equalizer type.

2 Adjust the effect

Press the [FM+] or [AM-] button.

Each time the button is pressed, the effects of Equalizer switch as shown below:

Setting of effect	Display
High	"Hi"
Middle	"Mid"
Low	"Lo"

3 Exit the Equalizer Control mode

Press the [EQ] button for at least 1 second.

When operation stops for 10 seconds, the Equalizer type at that time is registered and the Equalizer Control mode automatically closes.

Adjustment of Equalizer type at PRO

Adjusting the effect of an Equalizer type selected in 'Equalizer Control' when 'Equalizer mode' is "PRO".

1 Refer to 'Equalizer Control' (page 12) to select the Equalizer type.

2 Select the item for adjustment
Press the [FM+] or [AM-] button.

Each time the button is pressed, the items that can be adjusted switch as shown below.

3 Adjust the item

Press the [◀◀] or [▶▶] button.

Adjustment Item	Display	Range
Bass Center Frequency	"BasF"	60/70/80/100 or 150 Hz
Bass level	"BasLV"	-12 — +12
Bass Q Factor	"BasQ"	1.00/1.25/1.50/2.00
Bass Extend	"EXT"	ON/OFF
Middle Center Frequency	"MidF"	0.5/1.0/1.5/2.0 kHz
Middle level	"MidLV"	-12 — +12
Middle Q Factor	"MidQ"	1.0/2.0
Treble Center Frequency	"TreF"	10.0/12.5/15.0/17.5 kHz
Treble level	"TreLV"	-12 — +12



- According to the Bass Q Factor setting value, the frequencies that can be set in Bass Center Frequency change as shown below.

Bass Q Factor	Bass Center Frequency
1.00/1.25/1.50	60/70/80/100
2.00	60/70/80/150

- When the Bass Extend is set to ON, low frequency response is extended by 20%.

4 Exit the Equalizer Control mode

Press the [EQ] button for at least 1 second.

When operation stops for 10 seconds, the Equalizer type at that time is registered and the Equalizer Control mode automatically closes.

Memory preset of adjustment of Equalizer type

The 'Adjustment of Equalizer type at PRO' can be preset.

1 Refer to 'Adjustment of Equalizer type at PRO' (page 13) to adjust the Equalizer type.

2 Preset the adjusted value

Press the [1] — [3] button for at least 1 second.

Recalling a setting value

1 Enter the Equalizer Control mode

Press the [EQ] button.

"EQ PRO" is displayed.



- If "EQ EASY" is displayed, refer to 'Equalizer mode' (page 25) to set the mode to "EQ PRO".

2 Recall the setting value

Press the [1] — [3] button.

General features

Movie Select

Selecting the Movie display.

- 1 Enter the Movie Select mode**
Press the [MOVIE] button for at least 1 second.

"Movie" is displayed.

- 2 Select the Movie**
Press the [MOVIE] button.

Each time the button is pressed, the Movie switch as shown below:

Movie	Display
Scan of Movie	"MovieScn"
Movie 1	"Movie 1"
Movie 2	"Movie 2"
Movie 3	"Movie 3"
Movie 4	"Movie 4"
Movie 5	"Movie 5"
Movie 6	"Movie 6"
Movie 7	"Movie 7"
Movie 8	"Movie 8"
OFF	"MovieOff"

- 3 Exit the Movie Select mode**
Press the [MOVIE] button for at least 1 second.

When operation stops for 10 seconds, Movie at that time is registered and the Movie Select mode automatically closes.

Switching Display

Switching the information displayed.

- Press the [DISP] button.**

Each time the button is pressed the display switches as shown below.

In Tuner source

Information	Display
Frequency	
Station name or Frequency	"SNPS"
Character	
Clock	

In CD & External disc source

Information	Display
Play time & Track number	
Disc name	"DNPS"
Disc title	"D-Title"
Track title	"T-Title"
Character	
Clock	

In MP3/WMA source

Information	Display
Play time & Track number	
Folder name	"Folder"
File name	"File"
Song title & Artist name	"Title"
Album name	"Album"
Character	
Clock	

In Tape source

Information	Display
Play side & Tape counter	
Character	
Clock	

In Auxiliary input source

Information	Display
Auxiliary input name	
Character	
Clock	

In Standby mode

Information	Display
Character & Graphic	
Clock & Graphic	
Clock	



- If the Disc title, Track title, Song title & Artist name, or Album name & Artist name is selected when the disc which does not have Disc title, Track title, Song title, Album name, or Artist name is played, track number and play time are displayed.

Illumination Color Select

Setting the color of the display.

1 Enter the Illumination Color Select mode

Press the [COL] button.

"Illumi" is displayed.

2 Select the Illumination Color

Press the [COL] button.

Each time the button is pressed, the Illumination Color switches as shown below:

Illumination Color	Display
Scan of "Blue" to "Mint"	"V.Color"
Blue	"Blue"
Mars Red	"Mars Red"
White	"White"
Lavender	"Lavender"
Muscat	"Muscat"
Pink	"Pink"
Sky Blue	"Sky Blue"
Lime	"Lime"
Violet	"Violet"
Aqua	"Aqua"
Orange	"Orange"
Mint	"Mint"
User Color	"RX/GX/BX"



- "User Color" enables the color set in 'User Illumination Color Setting' (page 15) to be recalled.

3 Exit the Illumination Color Select mode

Press the [COL] button for at least 1 second.

When operation stops for 10 seconds, the Illumination Color at that time is registered and the Illumination Color Select mode automatically closes.

User Illumination Color Setting

The Illumination Color by the adjustment of RGB can arbitrarily set.

1 Enter the Illumination Color Select mode

Press the [COL] button.

"Illumi" is displayed.

2 Select the Color for adjustment

Press the [◀◀] or [▶▶] button.

Each time the button is pressed, the colors that can be adjusted switch as shown below:

Adjustment Color	Display
Red	"R" is blinks
Green	"G" is blinks
Blue	"B" is blinks

3 Adjust the Color

Press the [FM+] or [AM-] button.

Each time the button is pressed, the intensity of color changes as shown below:

Intensity of color	Display
Turning off	"X0"
Weak	"X1"
⋮	⋮
Dark	"X4"

4 Exit the Illumination Color Select mode

Press the [COL] button for at least 1 second.

When operation stops for 10 seconds, the Illumination Color at that time is determined and the Illumination Color Select mode automatically closes.

Adjusting Clock

1 Select the clock display

Press the [DISP] button.

2 Enter clock adjustment mode

Press the [DISP] button for at least 1 second.

The ⊖ indicator blinks.

3 Adjust the hours

Press the [FM+] or [AM-] button.

Adjust the minutes

Press the [◀◀] or [▶▶] button.

4 Exit clock adjustment mode

Press the [DISP] button.

General features

Station/Disc Naming (SNPS/DNPS)

Attaching a title to a Station or CD.

1 Receive/play the station/disc you want to attach a title to



- Refer to the 'Switching Display' (page 14) and select either "DNPS" or "SNPS". No name can be attached to the source if "DNPS" or "SNPS" cannot be selected for it.

2 Enter name set mode

Press the [NAME.S] button for at least 2 seconds.

"Name Set" is displayed.

3 Move the cursor to the enter character position

Press the [◀◀] or [▶▶] button.

4 Select the character type

Press the [▶II] button.

Each time the button is pressed the character type switches as shown below.

Character type	Display
Alphabet upper case	"A"
Alphabet lower case	"a"

5 Select the characters

Press the [FM+] or [AM-] button.



- Characters can be entered by using a remote with a number buttons.
Example: If "DANCE" is entered.

Character	Button	Times pressed
"D"	[3]	1
"A"	[2]	1
"N"	[6]	2
"C"	[2]	3
"E"	[3]	2

6 Repeat steps 3 through 5 and enter the name.

7 Exit name set mode

Press the [NAME.S] button.



- When operation stops for 10 seconds the name at that time is registered, and Name Set mode closes.
- Memory numbers

- FM & AM: 30 stations
- Internal CD player: 10 discs
- External CD changer/ player: Varies according to the CD changer/ player. Refer to the CD changer/ player manual.
- The title of station/CD can be changed by the same operation used to name it.

Auxiliary Input Display Setting

Selecting the display when this device is switched to Auxiliary input source.

1 Select Auxiliary input source

Press the [SRC] button.

Select the "AUX" display.

2 Enter Auxiliary input display setting mode

Press the [NAME.S] button for at least 2 seconds.

"Name Set" is displayed

3 Select the Auxiliary input display

Press the [◀◀] or [▶▶] button.

Each time the button is pressed it switches through the below displays.

- "AUX"
- "TV"
- "VIDEO"
- "GAME"
- "PORTABLE"
- "DVD"

4 Exit Auxiliary input display setting mode

Press the [NAME.S] button.



- When operation stops for 10 seconds, the name at that time is selected, and Auxiliary input display setting mode closes.
- The Auxiliary Input Display can be set only when the built-in auxiliary input or the auxiliary input of optional KCA-S210A is used.
- If this unit is removed from the battery, the Auxiliary Input name is returned to "AUX".

Tuner features

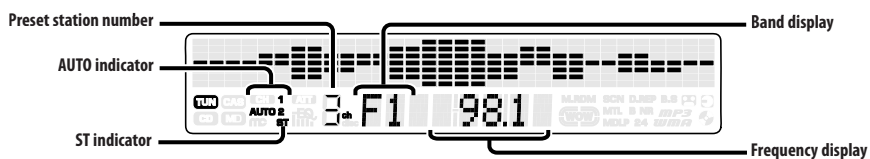
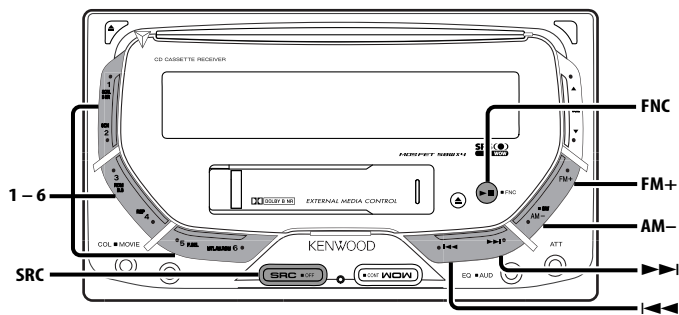

Tuning

Selecting the station.

1 Select tuner source

Press the [SRC] button.

Select the "TUNER" display.

2 Select the band

Press the [FM+] or [AM-] button.

Each time the [FM+] button is pressed it switches between the FM1, FM2, and FM3 bands.

3 Tune up or down band

Press the [◀◀] or [▶▶] button.



- During reception of stereo stations the "ST" indicator is ON.

Function of remote

Direct Access Tuning

Entering the frequency and tuning.

1 Select the band

Press the [FM] or [AM] button.

2 Enter Direct Access Tuning mode

Press the [DIRECT] button on the remote.

"----" is displayed.

3 Enter the frequency

Press the number buttons on the remote.

Example:

Desired frequency	Press button
92.1 MHz (FM)	[9], [2], [1]
810 kHz (AM)	[8], [1], [0]

Canceling Direct Access Tuning

Press the [DIRECT] button on the remote.

Tuner features

Station Preset Memory

Putting the station in the memory.

1 Select the band

Press the [FM+] or [AM-] button.

2 Select the frequency to put in the memory

Press the [◀◀] or [▶▶] button.

3 Put the frequency in the memory

Press the desired [1] — [6] button for at least 2 seconds.

The preset number display blinks 1 time.

On each band, 1 station can be put in the memory on each [1] — [6] button.

Auto Memory Entry

Putting a station with good reception in the memory automatically.

1 Select the band for Auto Memory Entry

Press the [FM+] or [AM-] button.

2 Enter Function mode

Press the [FNC] button for at least 1 second.

"Function" is displayed.

3 Select the Auto Memory Entry mode

Press the [FM+] or [AM-] button.

Select the "A-Memory" display.

4 Open Auto Memory Entry

Press the [◀◀] or [▶▶] button for at least 2 seconds.

When 6 stations that can be received are put in the memory Auto Memory Entry closes.

Preset Tuning

Calling up the stations in the memory.

1 Select the band

Press the [FM+] or [AM-] button.

2 Call up the station

Press the desired [1] — [6] button.

Cassette player features

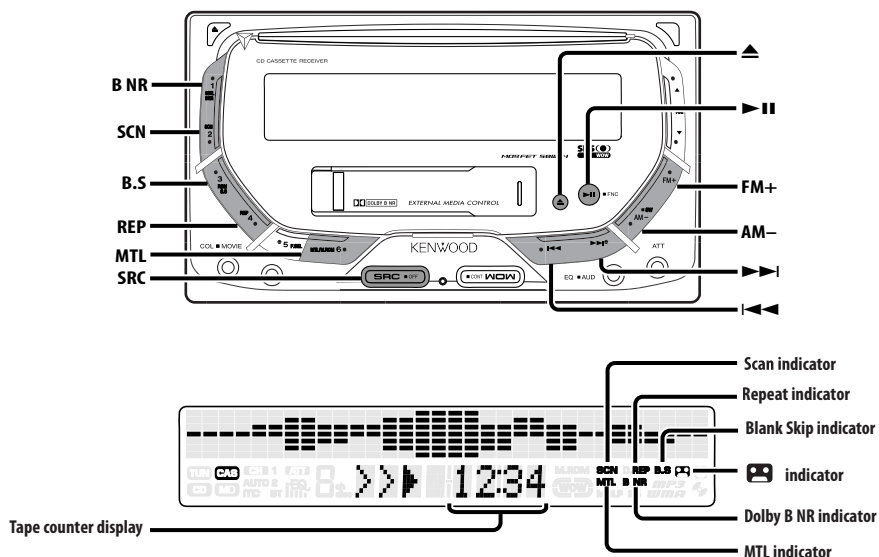

Playing Cassette Tapes

When the Cassette Tape is inserted

Press the [SRC] button.

Select the "TAPE" display.



- When there's a Cassette Tape inserted, the indicator is ON.

When you want to listen to the reverse side

Press the [▶||] button at the same time.

Eject the Cassette Tape

Press the [▲] button.

Fast Forwarding and Rewinding

Fast Forwarding

Press the [FM+] button.

When the [▶||] button is pressed it releases.

Rewinding

Press the [AM-] button.

When the [▶||] button is pressed it releases.

Dolby B NR

Press the [B NR] button.

Each time the button is pressed the Dolby B NR turns ON or OFF.

When it's ON, "B NR On" is displayed.

Selecting the Tape type

Press the [MTL] button.

Each time the button is pressed the Tape type switches as shown below.

Tape type	Display
CrO ₂ (Type II), FeCr (Type III), Metal (Type IV)	"MTL On"
Normal (Type I)	"MTL Off"

Cassette player features

DPSS (Direct Program Search System)

Indicating the songs to skip, and Fast Forwarding or Rewinding.

Skipping to a later song

Press the [▶▶] button.

Each time the button is pressed the number of songs skipped increases.

Skipping to a previous song

Press the [◀◀] button.

Each time the button is pressed the number of songs skipped increases.

Canceling DPSS

Press the [▶II] button.



- During the songs first 5 seconds the previous song may be recognized as the current song.
- As many as 9 songs can be skipped.

DPSS with the Remote

Designating the song to be skipped with the remote control number buttons.

1 Designate the song to skip

Press number buttons on the remote.

2 Skipping to a later song

Press the [▶▶] button.

Skipping to a previous song

Press the [◀◀] button.

Canceling DPSS

Press the [▶II] button.



- During the songs first 5 seconds there may be a times when the previous track is recognized as the current track.
- As many as 9 songs can be skipped.

Blank Skip

Fast forwarding automatically when an unrecorded portion continues for at least 10 seconds.

Press the [B.S] button.

Each time the button is pressed the Blank Skip turns ON or OFF.

When it's ON, "B.S On" is displayed.

Index Scan

Playing the first part of each song on the tape you are listening to and searching for the song you want to listen to.

1 Start Index Scan

Press the [SCN] button.

"IDX SCAN" is displayed.

2 Release it when the song you want to listen to is played

Press the [SCN] button.

Music Repeat

Repeating the present song.

Press the [REP] button.

Each time the button is pressed the Music Repeat turns ON or OFF.

When it's ON, "Repeat" is displayed.

CD/ MP3/ WMA/ External disc control features

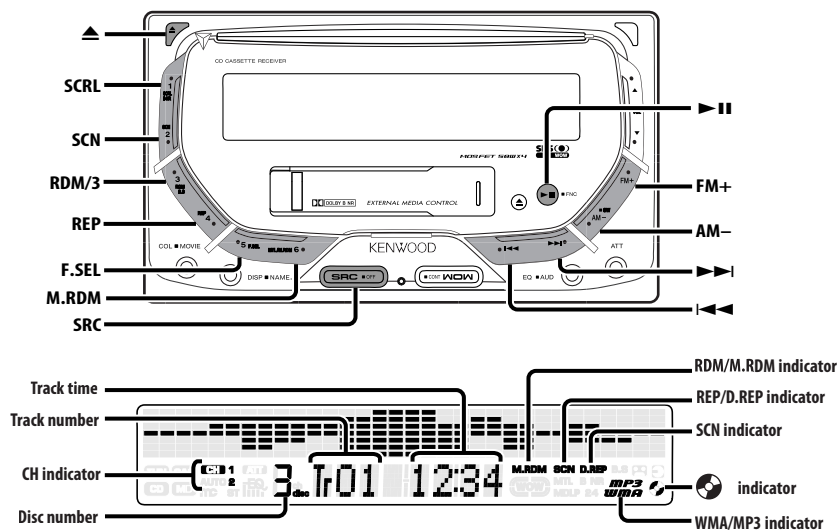

Playing CD & MP3/WMA

When a CD is inserted

Press the [SRC] button.

Select the "CD" display.



- When a CD is inserted, the indicator is ON.
- During MP3 is playing, the "MP3" indicator is ON.
- During WMA is playing, the "WMA" indicator is ON.

Pause and play

Press the [▶||] button.

Each time the button is pressed it pauses and plays.

Eject the CD

Press the [▲] button.



- Do not attach an adapter to an 8cm (3 in.) CD. Inserting an 8cm CD with an adapter into this unit may cause damage.



- The MP3/WMA media that this unit can play are CD-ROM, CD-R, and CD-RW. The medium formats must be ISO 9660 Level 1, Level 2, Joliet, or Romeo. The methods and precautions to be followed for writing MP3/WMA data are covered in 'Notes on playing MP3/WMA' (page 8). Check that section before creating your MP3/WMA media.

CD/ MP3/ WMA/ External disc control features

Playing External Disc

Playing discs set in the optional accessory disc player connected to this unit.

Press the [SRC] button.

Select the display for the disc player you want.

Display examples:

Display	Disc player
"CD CH"	CD changer
"MD CH"	MD changer

Pause and play

Press the [▶II] button.

Each time the button is pressed it pauses and plays.



- Disc 10 is displayed as "0".
- The functions that can be used and the information that can be displayed will differ depending on the external disc players being connected.

Fast Forwarding and Reversing

Fast Forwarding

Hold down on the [▶▶] button.

Release your finger to play the disc at that point.

Reversing

Hold down on the [◀◀] button.

Release your finger to play the disc at that point.

Track/File Search

Searching for a song on the disc or in the MP3/ WMA folder.

Press the [◀◀] or [▶▶] button.

Function of disc changer/ MP3/ WMA

Disc Search/Folder Search

Selecting the disc set in the Disc changer or the folder recorded on the MP3/WMA media.

Press the [AM-] or [FM+] button.

Function of remote

Direct Track/File Search

Doing Track/File Search by entering the track/file number.

1 Enter the track/file number

Press the number buttons on the remote.

2 Do Track/File Search

Press the [◀◀] or [▶▶] button.

Canceling Direct Track/File Search

Press the [▶II] button.

Function of disc changers with remote

Direct Disc Search

Doing Disc Search by entering the disc number.

1 Enter the disc number

Press the number buttons on the remote.

2 Do Disc Search

Press the [DISC+] or [DISC-] button.

Canceling Direct Disc Search

Press the [▶II] button.



- Input "0" to select disc 10.

Track/File/Disc/Folder Repeat

Replaying the song, disc in the Disc changer or MP3/WMA folder you're listening to.

Press the [REP] button.

Each time the button is pressed the Repeat Play switches as shown below.

In CD & External disc source

Repeat play	Display
Track Repeat	"Repeat"
Disc Repeat (In Disc Changer)	"D-Repeat"
OFF	

In MP3/WMA source

Repeat play	Display
File Repeat	"File REP"
Folder Repeat	"Fold.REP"
OFF	

Scan Play

Playing the first part of each song on the disc or MP3/WMA folder you are listening to and searching for the song you want to listen to.

1 Start Scan Play

Press the [SCN] button.

"Scan" is displayed.

2 Release it when the song you want to listen to is played

Press the [SCN] button.

Random Play

Play all the songs on the disc or MP3/WMA folder in random order.

Press the [RDM] button.

Each time the button is pressed Random Play turns ON or OFF.

When it's ON, "Random" is displayed.



- When the [▶▶] button is pressed, the next song select starts.

Function of disc changer

Magazine Random Play

Play the songs on all the discs in the disc changer in random order.

Press the [M.RDM] button.

Each time the button is pressed the Magazine Random Play turns ON or OFF.

When it's ON, "M-Random" is displayed.



- When the [▶▶] button is pressed, the next song select starts.

Function of MP3/WMA

Folder Select

Quickly selecting the folder you want to listen to.

1 Enter Folder Select mode

Press the [F.SEL] button.

During Select mode the folder information is displayed as shown below.

Folder name display

Displays the current folder name.



2 Select the folder level

Press the [FM+] or [AM-] button.

With the [FM+] button you move 1 level down and with the [AM-] button 1 level up.

Selecting a folder in the same level

Press the [◀◀] or [▶▶] button.

With the [◀◀] button you move to the previous folder, and with the [▶▶] button to the next folder.

Returning to the top level

Press the [3] button.

3 Decide the folder to play

Press the [▶II] button.

The Folder Select mode releases, and the MP3/WMA in the folder being displayed is played.



- The methods for moving to other folders in the folder select mode are different from those in the folder search mode.

See 'Notes on playing MP3/WMA' (page 8) for details.

Canceling the Folder Select mode

Press the [F.SEL] button.

Text/Title Scroll

Scrolling the displayed CD text, MP3/WMA text, or MD title.

Press the [SCRL] button.

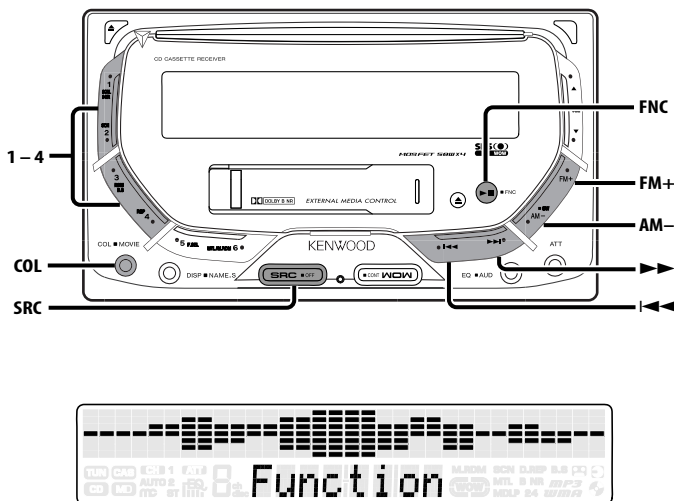

Function Set

Setting during operation beep sound etc. functions.

The Function Set basic operation method is explained here. The reference for the Function items and their setting content is after this operation explanation.

1 Enter Function Set mode

Press the [FNC] button for at least 1 second.

"Function" is displayed.

2 Select the Function Set item

Press the [FM+] or [AM-] button.

Example: When you want to set the beep sound select the "BEEP" display.

3 Set the Function Set item

Press the [◀◀] or [▶▶] button.

Example: When "BEEP" is selected, each time the button is pressed it switches "BEEP On" or "BEEP Off". Select 1 of them as the setting.

You can continue by returning to step 2 and setting other items.

4 Exit Function Set mode

Press the [FNC] button.



- When other items that are applicable to the basic operation method above are displayed afterwards their setting content chart is entered. (Normally the uppermost setting in the chart is the original setting.) Also, the explanation for items that aren't applicable are entered step by step.

In Standby mode

Illumination Color Mode

Setting the Illumination Color Mode of your display.

Display	Setting
"COL Sync"	The color of your display changes from one color to another during volume adjustment and during Attenuator being ON.
"COL Fix"	Fix the color set.

In Standby mode

Contrast Adjustment

Adjusting the display contrast.

Display and Setting
"CONT 1"
⋮
"CONT 6" (Original setting)
⋮
"CONT 11"

In Standby mode

Touch Sensor Tone

Setting the operation check sound (beep sound) ON/OFF.

Display	Setting
"BEEP On"	Beep is heard.
"BEEP Off"	Beep canceled.

In Standby mode

Switching preout

Switching the preout between the rear and subwoofer. (In subwoofer it outputs without effect from the fader control.)

Display	Setting
"SWPRE R"	Rear preout.
"SWPRE SW"	Subwoofer preout.

In Standby mode

Opening Demonstration

Setting the Demonstration when Power is turned ON.

Display	Setting
"Open On"	Demonstration is carried out when Power is turned ON.
"Open Off"	Demonstration is not carried out when Power is turned ON.

In Standby mode

Equalizer mode

Setting the method of adjusting Equalizer types.

Display	Setting
"EQ EASY"	The effects of Equalizer type can be adjusted among 3 levels.
"EQ PRO"	Equalizer types can be adjusted by Bass, Middle, and Treble.

Function Set

In Standby mode

Security Code

Because authorization by the Security Code is required when it's removed from the vehicle, personalizing this unit is by using the Security Code is a help in preventing theft.



- When the Security Code function is activated, the code can't be changed and the function can't be released. Note, the Security Code can be set as the 4 digit number of your choice.

1 Select the Security Code mode

Press the [FM+] or [AM-] button.

Select the "CODESTBY" display.

2 Enter Security Code mode

Press the [COL] button for at least 2 seconds.

When "WRITE" is displayed, "CODE *****" is displayed.

3 Enter the Security Code

Press the [1] — [4] button.

Example: If the Security Code is "3510".

Step	Button	Times pressed	Display
1	[1]	4	"3"
2	[2]	6	"5"
3	[3]	2	"1"
4	[4]	1	"0"

4 Confirm the Security Code

Press the [COL] button.

When "WRITE" is displayed, "1 CODE *****" is displayed.

5 Do the steps 3 through 4, and reenter the Security Code.

The Security Code function activates.



- When a Code different from step 3 is entered, repeat from step 3.

Press the Reset button and when it's removed from the battery power source

1 Turn the power ON.

2 Do the steps 3 through 4, and enter the Security Code.

"CODE OK!" is displayed.

The unit can be used.

In Standby mode

Navigation Mute

Mute the audio sound during Voice Guidance of navigation.

Display	Setting
"NavM Off"	Does not mute the sound.
"NavM On"	Mutes the sound.

In Standby mode

TEL Mute

You can set to mute the sound when a call comes in.

Display	Setting
"TelM Off"	Does not mute the sound.
"TelM On"	Mutes the sound.

In Standby mode

Built-in Auxiliary input Setting

Set the Built-in Auxiliary Input function.

Display	Setting
"AUX Off"	When selecting the source there's no Auxiliary Input.
"AUX On"	When selecting the source there's Auxiliary Input.

In Standby mode

Built-in Amp Mute Setting

Toggles ON or OFF the mute control on the built-in amplifier.

Turning ON this control enhances the preout quality.

Display	Setting
"AmpM Off"	The built-in amplifier activates.
"AmpM On"	The built-in amplifier deactivates.

In Standby mode

Security Indicator

A red indicator will blink on the unit after the ACC is set to OFF, warning potential thieves.

Display	Setting
"S.I Off"	LED OFF.
"S.I On"	LED flashes.

In Standby mode

CD Read Setting

When there is a problem on playing a CD with special format, this setting play the CD by force.

Display	Setting
"CD READ1"	Play CD and MP3/WMA.
"CD READ2"	Play CD by force.



- Setting "CD READ 2" cannot play MP3/WMA. Some music CDs may not be played back even in the "CD READ 2" mode.

In Tuner mode

Tuning Mode

Sets the tuning mode.

Tuning mode	Display	Operation
Auto seek	"Auto 1"	Automatic search for a station.
Preset station seek	"Auto 2"	Search in order of the stations in the Preset memory.
Manual	"Manual"	Normal manual tuning control.

In FM reception

Monaural Reception

Noise can be reduced when stereo broadcasts are received as monaural.

Display	Setting
"MONO Off"	The monaural reception is OFF.
"MONO On"	The monaural reception is ON.

In Tuner mode

Auto Memory Entry

For the operation method refer to 'Auto Memory Entry' (page 18).

In CD/MP3/WMA/External disc control mode

Text Scroll

Setting the displayed text scroll.

Display	Setting
"SCL Auto"	Repeats scroll.
"SCL Manu"	Scrolls when the display changes.



- The text scrolled is shown below.
 - CD text
 - Folder name/ File name/ Song title/ Artist name/ Album name
 - MD title

Basic Operations of remote

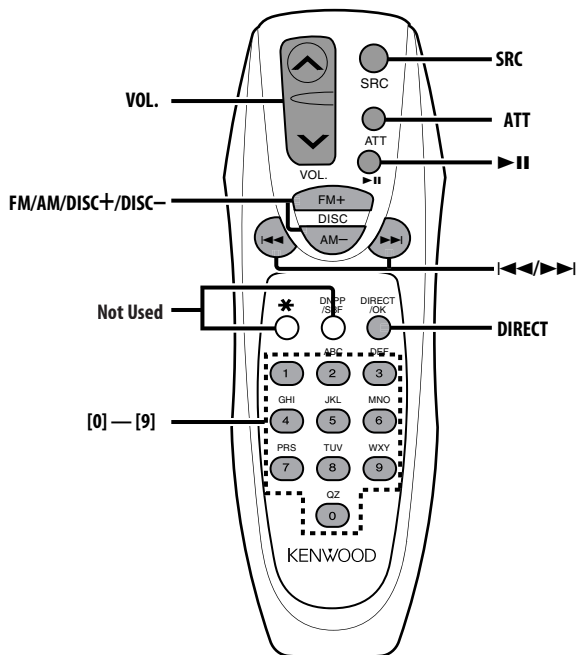

Loading and Replacing the battery

Use two "AA"-size batteries.

Slide the cover while pressing downwards to remove it as illustrated.

Insert the batteries with the + and - poles aligned properly, following the illustration inside the case.

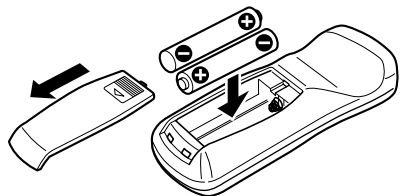

⚠ WARNING

- Store unused batteries out of the reach of children. Contact a doctor immediately if the battery is accidentally swallowed.



- Do not set the remote on hot places such as above the dashboard.

Basic operations

[VOL.] buttons

Adjusting the volume.

[SRC] button

Each time the button is pressed the source switches.

For the source switching order refer to 'Selecting the Source' (page 10).

[ATT] button

Turning the volume down quickly.

When it is pressed again it returns to the previous level.

In Tuner source

[FM]/ [AM] buttons

Select the band.

Each time the [FM] button is pressed it switches between the FM1, FM2, and FM3 bands.

[◀◀]/ [▶▶] buttons

Tune up or down band.

[0] — [9] buttons

Press buttons [1] — [6] to recall preset stations.

[DIRECT] button

Enters and cancels the 'Direct Access Tuning' (page 17) mode.

In Cassette tape source

[◀◀]/ [▶▶] buttons

Do 'DPSS (Direct Program Search System)' (page 20).

[▶ II] button

Plays the reverse side of the tape.

[FM] button

Fast forwards the tape.

When the [▶ II] button is pressed it releases.

[AM] button

Rewinds the tape.

When the [▶ II] button is pressed it releases.

[0] — [9] buttons

When in 'DPSS with the Remote' (page 20) enter the number of songs.

In Disc source

[◀◀]/ [▶▶] buttons

Doing track/file forward and backward.

[DISC+]/ [DISC-] buttons

Doing disc/folder forward and backward.

[▶ II] button

Each time the button is pressed the song pauses and plays.

[0] — [9] buttons

When in 'Direct Track/File Search' (page 22) and 'Direct Disc Search' (page 22), enter the track/file/disc number.

Accessories

Accessories

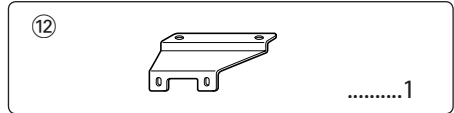
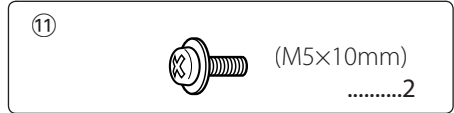
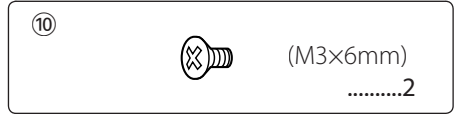
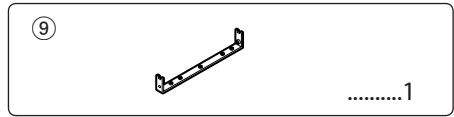
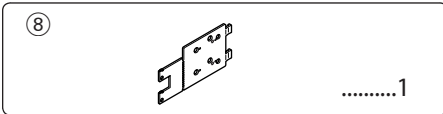
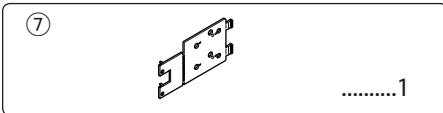
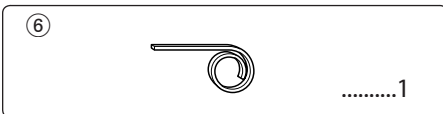
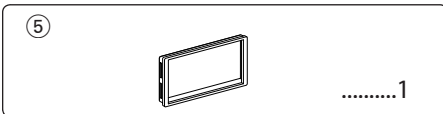
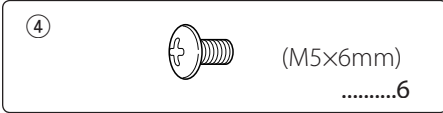
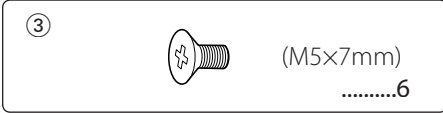
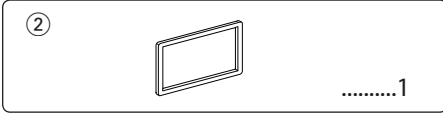
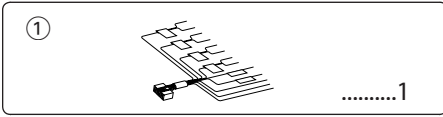

Installation Procedure

Installation Procedure

1. To prevent a short circuit, remove the key from the ignition and disconnect the ⊖ battery.
2. Make the proper input and output wire connections for each unit.
3. Connect the speaker wires of the wiring harness.
4. Connect the wiring harness wires in the following order: ground, battery, ignition.
5. Connect the wiring harness connector to the unit.
6. Install the unit in your car.
7. Reconnect the ⊖ battery.
8. Press the reset button.

▲WARNING

If you connect the ignition wire (red) and the battery wire (yellow) to the car chassis (ground), you may cause a short circuit, that in turn may start a fire. Always connect those wires to the power source running through the fuse box.



- If your car's ignition does not have an ACC position, connect the ignition wires to a power source that can be turned on and off with the ignition key. If you connect the ignition wire to a power source with a constant voltage supply, as with battery wires, the battery may die.
- If the console has a lid, make sure to install the unit so that the faceplate will not hit the lid when closing and opening.
- If the fuse blows, first make sure the wires aren't touching to cause a short circuit, then replace the old fuse with one with the same rating.
- Insulate unconnected wires with vinyl tape or other similar material. To prevent a short circuit, do not remove the caps on the ends of the unconnected wires or the terminals.
- Connect the speaker wires correctly to the terminals to which they correspond. The unit may be damaged or fail to work if you share the ⊖ wires or ground them to any metal part in the car.
- When only two speakers are being connected to the system, connect the connectors either to both the front output terminals or to both the rear output terminals (do not mix front and rear). For example, if you connect the ⊕ connector of the left speaker to a front output terminal, do not connect the ⊖ connector to a rear output terminal.
- After the unit is installed, check whether the brake lamps, blinkers, wipers, etc. on the car are working properly.
- Mount the unit so that the mounting angle is 30° or less.

Connecting Wires to Terminals

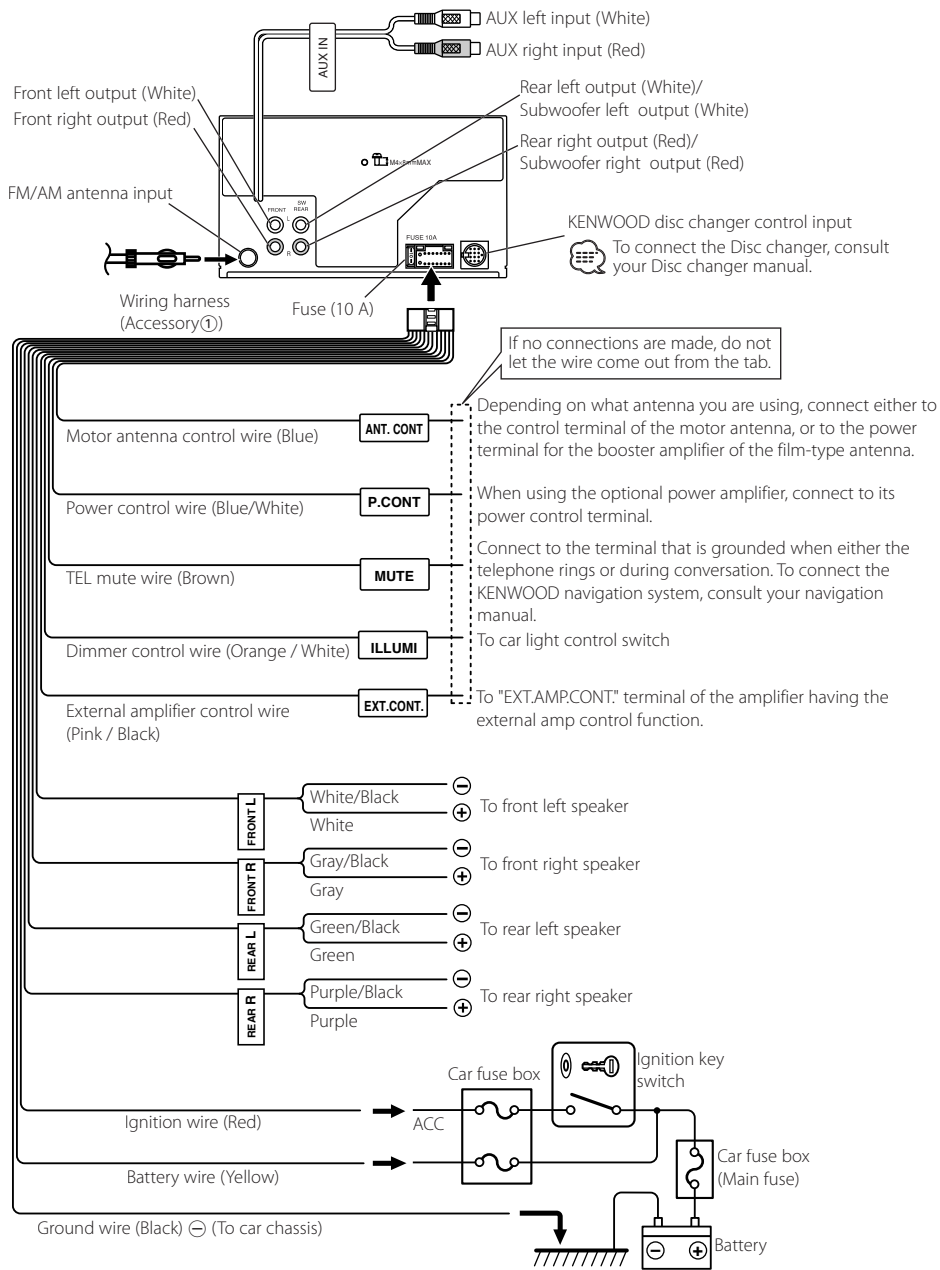

Installation (For TOYOTA, NISSAN Car etc.)



When performing a check of the CD operation prior to installation, place this unit in a horizontal position and perform a loading/eject of the CD.

Installation

Install onto the car bracket using the supplied screws (M5 × 6 mm, M5 × 7 mm). The holes of the car bracket to use will differ depending on the car model.

When a ground wire is included in the wiring kit (which is sold separately), fasten the ground wire with the binding screw located on the rear panel of this unit.

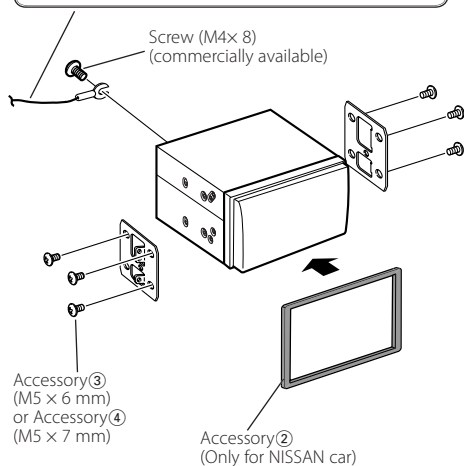

- During installation, do not use any screws except for those provided. The use of different screws might result in damage to the main unit.
- Damage may occur if a screwdriver or similar tool is used with excessive force during the installations.

Installation (For HONDA ACURA Car)

You can choose from three installation types to fit your car. Perform 'Assembly' before installation.

Assembly

Fit the projections on both sides of the Accessories ⑦ and ⑧ into the slits on the Accessory ⑤.

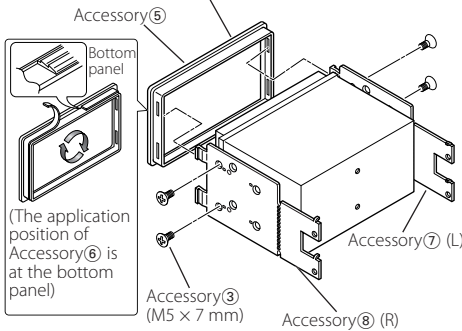

- During installation, do not use any screws except for those provided. The use of different screws might result in damage to the main unit.
- Damage may occur if a screwdriver or similar tool is used with excessive force during the installations.

Installation type 1

- 1 Use Accessory ④ to attach the unit which was assembled in Assembly.

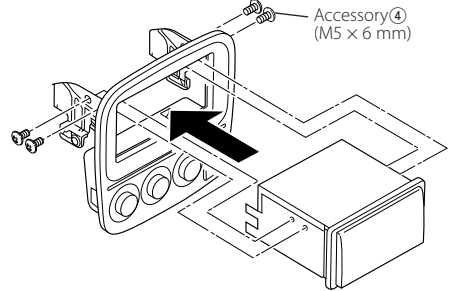

- 2 Install the center panel with the unit in your car



- The illustration shows an example of installation using a vehicle bracket. The shape of the bracket varies with the vehicle to be installed. Some bracket requires three screws (Accessory ④) on each side.
- If accessories ⑦ and ⑧ hit the inside of the console, preventing the unit from being attached tightly, snap their end parts off as shown below. shipped with the unit, as shown above

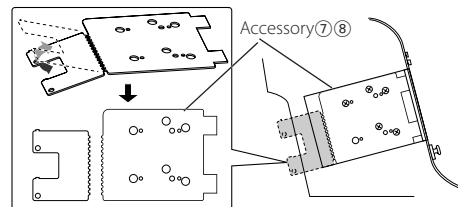

Be careful not to get injured with the new edge.

Installation type 2

- 1 Attach Accessory⑨ which was assembled in Assembly.

Accessory⑨ is to be fixed either to the center or bottom, depending on the car model.

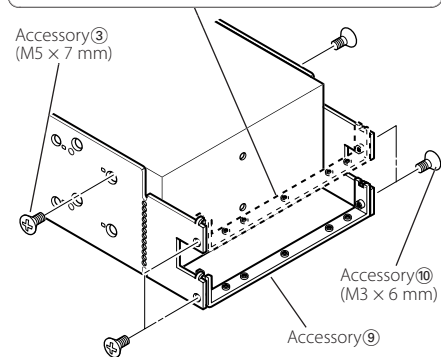

- 2 Remove the factory-installed car stereo and install the unit.

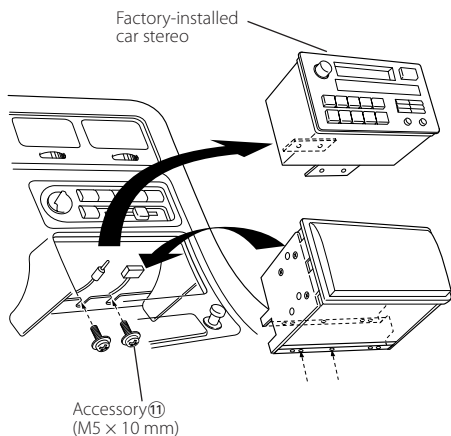

Installation type 3

- 1 Attach Accessory⑫ to Accessory⑨ which was assembled in Assembly.

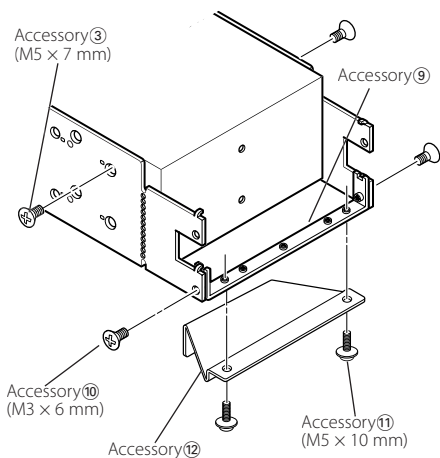

- 2 Remove the factory-installed car stereo and install the unit.

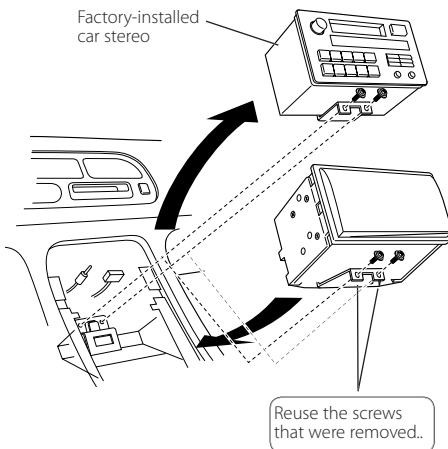

Troubleshooting Guide

What might seem to be a malfunction in your unit may just be the result of slight misoperation or miswiring. Before calling service, first check the following table for possible problems.

General

? The power does not turn ON.

- ✓ The fuse has blown.
 - ☞ Set the media you want to listen to, replace the fuse with one with the same rating.
- ✓ Speaker cable touches on chassis etc.
 - ☞ Wire or insulate the speaker cable properly and press the reset button.

? There's a source you can't switch.

- ✓ There's no media inserted.
 - ☞ Set the media you want to listen to. If there's no media in this unit, you can't switch to each source.
- ✓ The Disc changer isn't connected.
 - ☞ Connect the Disc changer. If the Disc changer isn't connected to its input terminal, You can't switch to an external disc source.

? The memory is erased when the ignition is turned OFF.

- ✓ The ignition and battery wire are incorrectly connected.
 - ☞ Connect the wire correctly, referring to the section on 'Connecting Wires to Terminals'.

? The TEL mute function does not work.

- ✓ The TEL mute wire is not connected properly.
 - ☞ Connect the wire correctly, referring to the section on 'Connecting Wires to Terminals'.
- ✓ The 'TEL Mute' (page 26) is OFF.
 - ☞ Turn it ON.

? The TEL mute function turns ON even though the TEL mute wire is not connected.

- ✓ The TEL mute wire is touching a metal part of the car.
 - ☞ Pull the TEL mute wire away from the metal part of the car.

? No sound can be heard, or the volume is low.

- ✓ The fader or balance settings are set all the way to one side.
 - ☞ Center the fader and balance settings.
- ✓ The input/output wires or wiring harness are connected incorrectly.
 - ☞ Reconnect the input/output wires or the wiring harness correctly. See the section on 'Connecting Wires to Terminals'.
- ✓ The cassette tape is bad.
 - ☞ Try playing another cassette tape. If works fine, the first tape was bad.
- ✓ The values of Volume offset are low.
 - ☞ Turn up the Volume offset, referring to the section on 'Audio Control' (page 11).
- ✓ The 'Built-in Amp Mute Setting' (page 26) is ON.
 - ☞ Turn it OFF.

? The sound quality is poor or distorted.

- ✓ One of the speaker wires is being pinched by a screw in the car.
 - ☞ Check the speaker wiring.
- ✓ The tape head is dirty.
 - ☞ Clean the tape head.
- ✓ The speakers are not wired correctly.
 - ☞ Reconnect the speaker wires so that each output terminal is connected to a different speaker.

? The Touch Sensor Tone doesn't sound.

- ✓ The preout jack is being used.
 - ☞ The Touch Sensor Tone can't be output from the preout jack.

? The Dimmer function doesn't work.

- ✓ The Dimmer wire isn't connected correctly.
 - ☞ Check the Dimmer wire connection.

Tuner source

? Radio reception is poor.

- ✓ The car antenna is not extended.
ⓘ Pull the antenna out all the way.
- ✓ The antenna control wire is not connected.
ⓘ Connect the wire correctly, referring to the section on 'Connecting Wires to Terminals'.

? The desired frequency can't be entered with the Direct Access Tuning.

- ✓ A station that can't be received is being entered.
ⓘ Enter a station that can be received.
- ✓ You're trying to enter a frequency with a 0.01 MHz unit.
ⓘ What can be designated in the FM band is to 0.1 MHz.

Cassette tape source

? Can't remove tape.

- ✓ The cause is that more than 10 minutes has elapsed since the vehicle ACC switch was turned OFF.
ⓘ The tape can only be removed within 10 minutes of the ACC switch being turned OFF. If more than 10 minutes has elapsed, turn the ACC switch ON again and press the Eject button.

? The DPSS, Tape Advance and Music Repeat don't operate correctly.

- ✓ The space between the songs on the tape can't be recognized because it's too short.
ⓘ Have at least 4 seconds between songs.
- ✓ The space between songs can't be recognized because there's too much noise between songs.
ⓘ Reduce the noise between songs.

? The blank skip doesn't work.

- ✓ Because noise is too loud, the non-recorded part can't be recognized.
ⓘ Reduce the noise between songs.

? Blank Skip functions at places that are recorded.

- ✓ Because the recording level is low, it's recognized as not recorded.
ⓘ Turn Blank Skip OFF.

? 'Music Repeat' (page 20) is cancelled arbitrarily.

- ✓ The power was turned OFF or a source selection or other operation was performed.
ⓘ Music repeat is cancelled when the power is turned OFF or a source selection or other operation is performed.

Disc source

? "AUX EXT" is displayed without achieving External disc control mode.

- ✓ Unsupported disc changer is connected.
 - ☞ Use the disc changer mentioned in the 'About CD players/disc changers connected to this unit' (page 5) of the section on 'Safety precautions'.

? The specified disc does not play, but another one plays instead.

- ✓ The specified CD is quite dirty.
 - ☞ Clean the CD.
- ✓ The disc is loaded in a different slot from that specified.
 - ☞ Eject the disc magazine and check the number for the specified disc.
- ✓ The disc is severely scratched.
 - ☞ Try another disc instead.

? A CD ejects as soon as it is loaded.

- ✓ The CD is quite dirty.
 - ☞ Clean the CD, referring to the CD cleaning of the section on 'About CDs' (page 7).

? Can't remove disc.

- ✓ The cause is that more than 10 minutes has elapsed since the vehicle ACC switch was turned OFF.
 - ☞ The disc can only be removed within 10 minutes of the ACC switch being turned OFF. If more than 10 minutes has elapsed, turn the ACC switch ON again and press the Eject button.

? The disc won't insert.

- ✓ There's already another disc inserted.
 - ☞ Press the [▲] button and remove the disc.

? Direct Search can't be done.

- ✓ Another function is ON.
 - ☞ Turn Random Play or other functions OFF.

? Track Search can't be done.

- ✓ For the discs/folders first or last song.
 - ☞ For each disc/folder, Track Search can't be done in the backward direction for the first song or in the forward direction for the last song.

MP3/WMA source

? Cannot play an MP3/WMA.

- ✓ The media is scratched or dirty.
 - ☞ Clean the media, referring to the CD cleaning of the section on 'About CDs' (page 7).

? The sound skips when an MP3/WMA is being played.

- ✓ The media is scratched or dirty.
 - ☞ Clean the media, referring to the CD cleaning of the section on 'About CDs' (page 7).
- ✓ The recording condition is bad.
 - ☞ Record the media again or use another media.

? The MP3/WMA track time isn't displayed correctly.



- ✓ ---
 - ☞ There are times when it isn't displayed correctly according to the MP3/WMA recording conditions.

If the following situations, consult your nearest service center:

Even though the disc changer is connected, the Disc Changer source is not ON, with "AUX EXT" showing in the display during the Changer Mode.

The messages shown below display your systems condition.

EJECT:	No disc magazine has been loaded in the changer. The disc magazine is not completely loaded. ➤ Load the disc magazine properly. No CD in the unit. ➤ Insert the CD.
No Disc:	No disc has been loaded in the disc magazine. ➤ Load a disc into the disc magazine.
Error 04:	The CD is quite dirty. The CD is upside-down. The CD is scratched a lot. ➤ Clean the CD and load it correctly.
Error 05:	The CD is upside-down. ➤ Load the CD correctly.
Blank:	Nothing has been recorded on the MD.
No Track:	No tracks are recorded on the MD, although it has a title.
Error 77:	The unit is malfunctioning for some reason. ➤ Press the reset button on the unit. If the "Error-77" code does not disappear, consult your nearest service center.
Error 99:	Something is wrong with the disc magazine. Or the unit is malfunctioning for some reason. ➤ Check the disc magazine. And then press the reset button on the unit. If the "Error 99" code does not disappear, consult your nearest service center.
Hold:	The protective circuit in the unit activates when the temperature inside the automatic disc changer exceeds 60°C (140°F), stopping all operation. ➤ Cool down the unit by opening the windows or turning on the air conditioner. As the temperature falls below 60°C (140°F), the disc will start playing again.

No Name:	Attempted to display DNPS during the CD play having no disc names preset..
Load:	Discs are being exchanged in the Disc changer.
Reading:	The unit is reading the data on the disc.
 (Blink):	The CD player section is not operating properly. ➤ Reinsert the CD. If the CD cannot be ejected or the display continues to flash even when the CD has been properly reinserted, please switch off the power and consult your nearest service center.
 (Blink):	The tape player section is not operating properly. ➤ Reinsert the Tape. If the tape cannot be ejected or the display continues to flash even when the tape has been properly reinserted, please switch off the power and consult your nearest service center.
N/A File:	A MP3/WMA is played with a format that this unit can't support. ➤ ----
Protect:	A copy-protected file is played. ➤ ----

Specifications

Specifications subject to change without notice.

FM tuner section

Frequency range (200 kHz space)
: 87.9 MHz – 107.9 MHz
Usable sensitivity (S/N = 30dB)
: 9.3dBf (0.8 μ V/75 Ω)
Quieting Sensitivity (S/N = 50dB)
: 15.2dBf (1.6 μ V/75 Ω)
Frequency response (\pm 3.0 dB)
: 30 Hz – 15 kHz
Signal to Noise ratio (MONO)
: 70 dB
Selectivity (\pm 400 kHz)
: \geq 80 dB
Stereo separation (1 kHz)
: 30 dB

AM tuner section

Frequency range (10 kHz space)
: 530 kHz – 1700 kHz
Usable sensitivity (S/N = 20dB)
: 28 dB μ V (25 μ V)

Cassette player section

Tape speed
: 4.76 cm/sec.
Wow & Flutter (WRMS)
: 0.1 %
Frequency response (70 μ s)
: 40 Hz – 20 kHz (\pm 3 dB)
Separation (1 kHz)
: 35 dB
Signal to Noise ratio
Dolby NR Off : 50 dB
Dolby B NR On : 60 dB

CD player section

Laser diode
: GaAlAs
Digital filter (D/A)
: 8 Times Over Sampling
D/A Converter
: 1 Bit
Spindle speed
: 500 – 200 rpm (CLV)
Wow & Flutter
: Below Measurable Limit
Frequency response (\pm 1 dB)
: 10 Hz – 20 kHz

Total harmonic distortion (1 kHz)
: 0.01 %
Signal to Noise ratio
: 100 dB (1 kHz)
Dynamic range
: 93 dB
Channel separation
: 85 dB
MP3 Decode
: Compliant with MPEG-1/2 Audio Layer-3
WMA decode
: Compliant with Windows Media Audio

Audio section

Maximum output power
: 50 W \times 4
Full bandwidth power (at less than 1% THD)
: 22 W \times 4
Preout level / Load
: 1800mV/10k Ω
Preout impedance
: \leq 600 Ω

Auxiliary input

Frequency response (\pm 1 dB)
: 20 Hz – 20 kHz
Input Maximum Voltage
: 1200 mV
Input Impedance
: 100 k Ω

General

Operating voltage (11 – 16V allowable)
: 14.4 V
Current consumption
: 10 A
Installation Size (W x H x D)
: 178 x 100 x 155 mm
7 x 3-15/16 x 6-1/8 inch
Weight
: 2.3 kg (5.1 lbs)